

# Operator's Manual

# ASCO® Series 185 Automatic Transfer Switches 100 through 400 ampere sizes

## ⚠ DANGER

DANGER is used in this manual to warn of a hazard situation which, if not avoided, will result in death or serious injury.

## ⚠ WARNING

WARNING is used in this manual to warn of a hazardous situation which, if not avoided, could result in death or serious injury.

## ⚠ CAUTION

CAUTION is used in this manual to warn of a hazardous situation which, if not avoided, could result in minor or moderate injury.

An experienced licensed electrician must install the ATS.



100–230 ampere sizes

Refer to the outline and wiring drawings provided with your ASCO Series 185 ATS for all installation details.

ASCO Series 185 Automatic Transfer Switches (ATSs) are Listed under Underwriter's Laboratories Standard for Transfer Switch Equipment, UL-1008. They are intended for use only in optional standby systems in accordance with the National Electrical Code, NEC/NFPA 70, Article 702. This ATS is for use with 2-wire automatic-start generators only.

Refer to Application Information 381339-292 to confirm that you have selected the appropriate product for the intended installation.

This automatic transfer switch is intended for standby power applications in residential / light commercial use only.

**This product is not intended for emergency or life-support systems.**

If you have more stringent application requirements contact ASCO Power Technologies for other products suitable for critical applications.

### Rating Label

Each automatic transfer switch contains a rating label to define the loads and fault circuit withstand / closing ratings. Refer to the label on the transfer switch for specific values.

## ⚠ WARNING

Do not exceed the values on the rating label. Exceeding the rating can cause person injury or serious equipment damage.

TABLE OF CONTENTS	page
INSTALLATION .....	1
CONTROLLER .....	2-5
FUNCTIONAL TEST .....	6
SEQUENCE OF OPERATION .....	7
TROUBLESHOOTING .....	8-9
INDEX .....	10

### Nameplate

The Transfer Switch nameplate includes data for each specific ASCO Series 185 ATS. Use the ATS only within the limits shown on this nameplate.

### Catalog Number Identification

A typical Catalog Number is shown below with its elements explained. The example is for a D–design, 2 pole, 200 A, 220–240 V, in Type 1 indoor enclosure:

D 185      A      2      200      F      4      C

Neutral	Phase Poles	Amperes	Voltage	Controller	Enclosure
A – standard	2 – single $\emptyset$	100 200 230 260 400	F 220–240	4 – standard 4X – if accessories ordered	C – Type 1 M – Type 3R

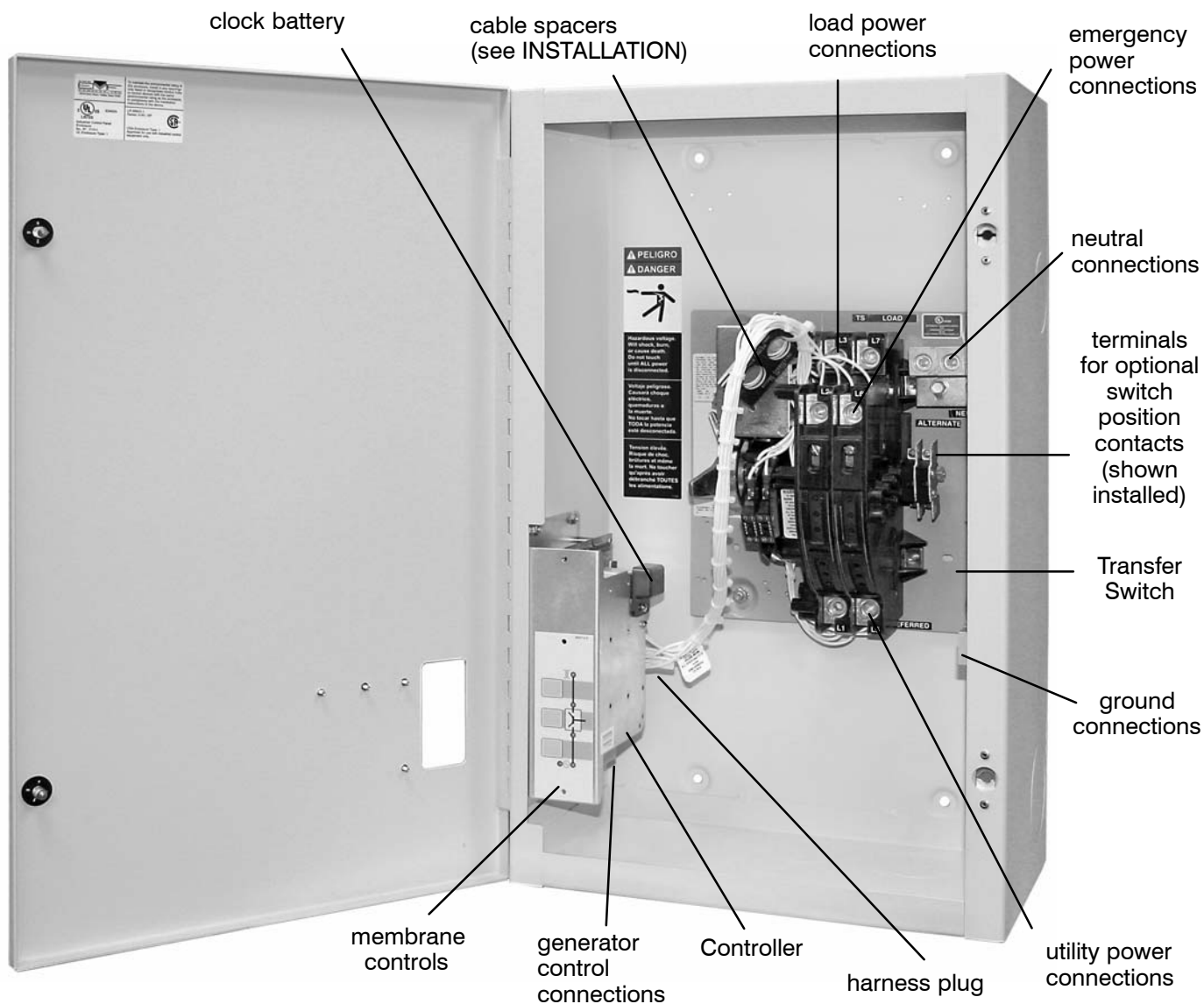

200 ampere size in typical enclosure with location of customer connections

Installation of the ASCO Series 185 automatic transfer switch (ATS) must be performed by a licensed electrician. It must be installed according to the National Electrical Code (NEC) and all local electrical code requirements. Remove the enclosure cover and inspect the ATS for shipping damage. If damage is evident do not install the ATS.

## 1 – Mounting

Refer to the enclosure outline drawing. Mount the ATS according to details and instructions shown on this diagram. Mount the ATS vertically to a rigid supporting structure. Level all mounting points by using flat washers behind the holes to avoid distortion of the enclosure.

### NOTICE

**MALFUNCTION or SHORTENED LIFE**  
Protect the automatic transfer switch from construction grit and metal chips to prevent malfunction or shortened life of the ATS.

Transfer switches rated 260 and 400 amperes are mounted on an insulator backing piece (installed behind the transfer switch). If the transfer switch is removed from the enclosure and then reinstalled, this insulator must be placed behind the transfer switch. See Figure 1.

### WARNING

**FLASH HAZARD – DAMAGE**  
Be sure that the insulator piece is installed behind the 260 and 400 ampere transfer switches.

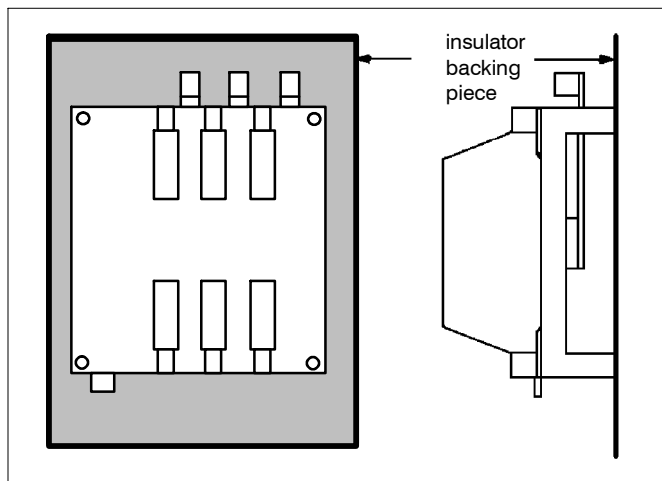

Figure 1. Insulator for 260 and 400 A.

## 2 – Electrical Power Connections

Refer to the wiring diagram. The ATS must be protected by suitably sized circuit breakers feeding the utility and generator source terminals. The rating of the circuit breakers must be based on the requirements of the National Electrical Code for its nameplate ampere and short circuit withstand ratings.

### ⚠ DANGER

**ELECTROCUTION HAZARD** Turn off utility power and turn off the generator to prevent electrocution when wiring the transfer switch.

### Cable Spacers for 150, 200, and 230 A

Three cable spacers are included with 150, 200, and 230 ampere transfer switches. Run the copper power cables through the cable spacers as shown in Figure 2. Position the cable spacers approximately 1½ inches from the terminal lugs.

### NOTICE

**CABLE LOOSENING DUE TO SHORT CIRCUIT**  
Install three cable spacers 1 1/2 inches from the power terminals to prevent the cables from loosening during a short-circuit condition on 150, 200, and 230 ampere transfer switches.

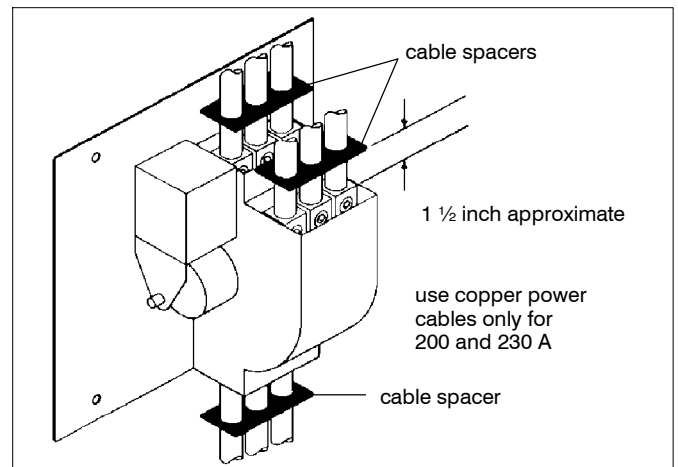

Figure 2. Cable spacers for 150, 200, and 230 A.

The Group 4 digital Controller is used in ASCO Series 185 automatic transfer switches. It provides the sensing, timing, and control functions for the ATS. This micro-processor-based controller includes built-in control buttons and status lights for control of the ATS and generator.

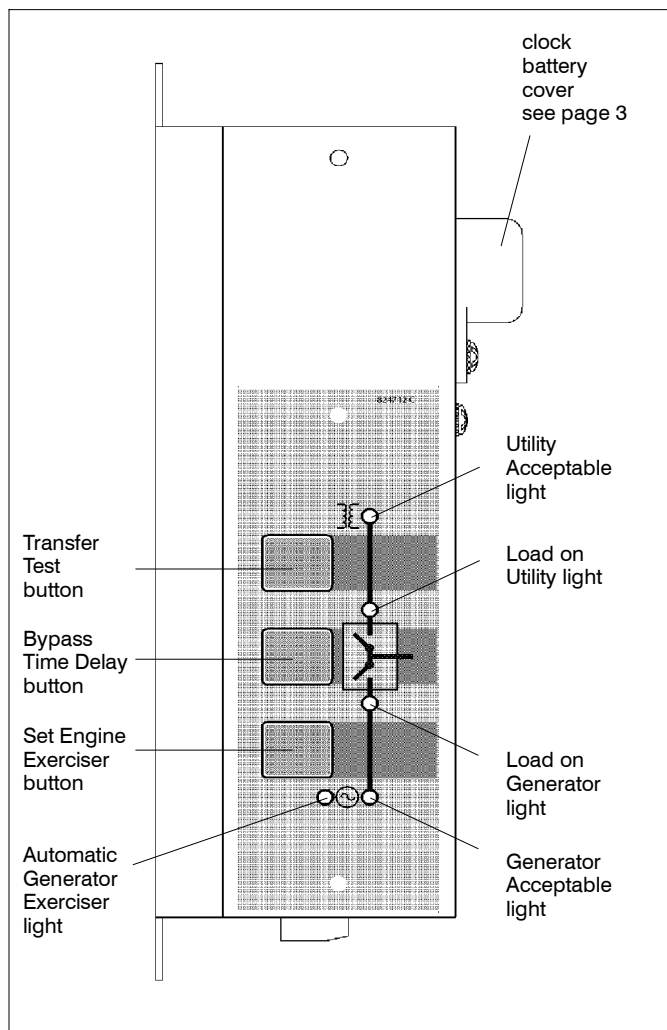

Figure 3. Front view of controller.

## 1 – Push Buttons

On the front control display are three push buttons that control the operation of the generator and the ATS.

### **⚠ CAUTION**

Before using the transfer test button, be sure that conditions are safe for running the generator and for load transfer.

#### **Transfer Test**

Use this button to test the system. This operation starts the generator and transfers the load. Be sure that conditions are safe to do this operation.

#### **Bypass Time Delay**

Use this button to cancel the active time delay or exercise period (stops the generator after cooldown).

#### **Set Engine Exerciser**

Use this button to set the automatic generator exerciser (page 3).

## 2 – Indicator Lights

On the front control display are five lights that indicate the status of the sources and the ATS.

#### **Utility Acceptable**

This light indicates that the utility voltage is acceptable for connection to the load.

#### **Generator Acceptable**

This light indicates that the generator voltage is acceptable for connection to the load.

#### **Load on Utility**

This light indicates that the load is connected to the utility.

#### **Load on Generator**

This light indicates that the load is connected to the generator.

#### **Automatic Generator Exerciser**

This light indicates the status of the generator exerciser:

- blinks during the exercise period (including cooldown).
- stays on when the exerciser has been set.
- is off when the exerciser has not been set.

### 3 – Generator Starting Contacts

The generator starting contacts connections are on the controller. Refer to the generator manual. Disconnect the generator battery and verify that the ignition switch is in the OFF position. Connect the generator starting wires to the appropriate terminals on terminal block TB7 as shown on the wiring diagram. For wiring convenience terminal block TB7 has a removable plug. See Figure 4 and Table A.

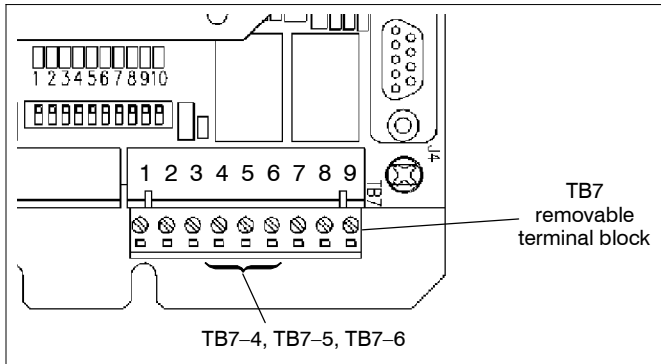

Figure 4. TB7 generator starting contact terminals.

Table A. Generator Start Connections

When the Utility fails	Terminals on Controller
contact closes	TB7-4 and TB7-5
contact opens	TB7-5 and TB7-6

### 4 – Settings

The time delay and sensor setting in the Group 4 controller are accessible on the inside. Refer to Tables B and C and to Figures 6 and 7. Use a ball-point pen or other pointed tool to slide the DIP switch actuators up or down to match setting shown.

All power must be off before making any changes.

The factory default settings are shown in Table G on page 5.

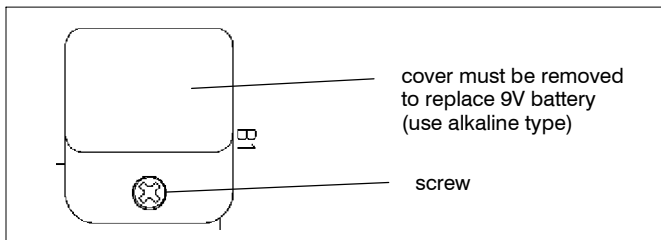

Figure 5. Battery replacement.

### 5 – Automatic Generator Exerciser

The built-in automatic generator exerciser can be set to exercise the generator for 20 minutes once every week.

#### Clock Battery

Be sure a fresh battery is installed and turned on. It will maintain the exerciser clock for about 24 hours in case of a power outage.

Recommended 9 volt alkaline batteries are (see Figure 5): *Duracell MN 1404, Everready 522, Panasonic 6AM6*

Turn on battery by putting S2 DIP switch actuator 10 in the on position (up). See Table B and Figure 6.

#### Exercise with or without Load

The generator should be exercised under load or follow the recommendations of the generator manufacturer. Be sure the exerciser is turned on. Then select either exercise with or without load. The ATS will transfer the load to the generator when the exercise with load is selected. See Figure 6 and Table B.

Table B. Generator Exercise Settings

Function	Factory Setting	DIP Switch	DIP Actuator	Actuator Position
clock battery	off	S2	10	on (up) off (down)
exerciser	off	S1	7	on (up) off (down)
with load or without load	without load	S1	8	with (up) without (down)

#### To Set Exerciser

Press and hold (5 seconds) the **Set Engine Exerciser** button. The exercise period occurs immediately and at approximately the same time weekly thereafter. The status light below the button blinks during the exercise period (including the cooldown). The light stays on to indicate that the exerciser has been set. If the light is off, the exerciser has not been set.

#### To Cancel an Active Exercise Period

Press the **Bypass Time Delay** button to stop an exercising generator. If exercise with load is set, the ATS retransfers the load to the utility, then stops the generator after cooldown.

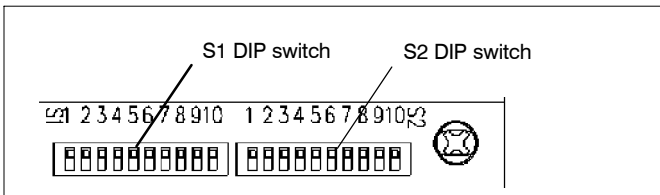

Figure 6. DIP switches S1 and S2 at the top right.

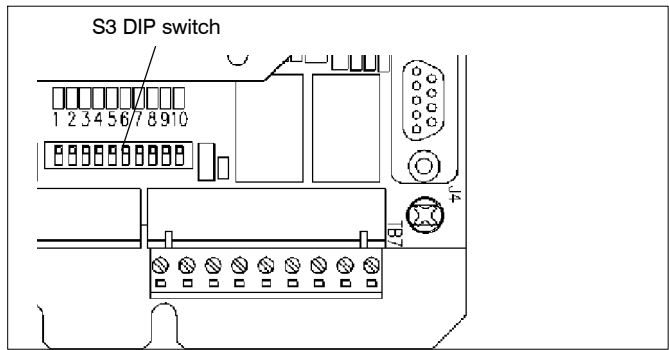

Figure 7. DIP switch S3 at the bottom center.

The time delay settings are shown in Figures 6 and 7 and in Table C. The sensor settings are shown in Figure 6 and in Table D. The standard (factory) settings are shown in Tables C, D, and H.

**Table C. Time Delay Settings**

Time Delay Description	Factory Setting	Settings	DIP Switch	DIP Actuator	Actuator Position
override momentary utility outages	3 seconds	1 second	S2	1	on (up)
		3 seconds	S2	1	off (down)
transfer to generator	10 seconds (approx.)	–	–	–	–
override momentary generator outages	4 seconds	4 second	S3	9	on (up)
		0	S3	9	off (down)
transfer to utility	5 minutes (approx.)	–	–	–	–
unloaded running (generator cooldown)	2 minutes	2 minutes	S1	10	on (up)
		5 minutes	S1	10	off (down)
load disconnect delay before transfer (and delay after transfer, if enabled)	0 seconds	0 seconds	S3	7, 8	both on (up)
		3 seconds	S3	7, 8	7 on (up), 8 off (down)
		10 seconds	S3	7, 8	7 off (down), 8 on (up)
		20 seconds	S3	7, 8	both off (down)

**Table D. Voltage and Frequency Settings**

Setting Description	Setting	Factory Setting	Settings	DIP Switch	DIP Actuator	Actuator Position
voltage	–	220 – 240 V	non-adjustable	S2	2	on (up)
frequency	nominal	60 Hz	50 Hz	S1	4	on (up)
			60 Hz	S1	4	off (down)
phase	–	single	non-adjustable	S1	6	on (up)
utility voltage	pickup	198 V	198 V	S1	3	on (up)
			209 V *	S1	3	off (down)
	dropout	187 V	198 V *	S1	1	off (down)
				S1	2	off (down)
			187 V	S1	1	on (up)
				S1	2	off (down)
			176 V	S1	1	off (down)
				S1	2	on (up)
154 V	S1	1	on (up)			
	S1	2	on (up)			
generator voltage	pickup	198 V	non-adjustable	–	–	–
	dropout	165 V				
generator frequency	pickup	57 Hz (nom 60 Hz) 48 Hz (nom 50 Hz)	non-adjustable	–	–	–
	dropout	51 Hz (nom 60 Hz) 43 Hz (nom 50 Hz)				

\* If the dropout voltage is set to 198 V, the pickup voltage must be set to 209 V.

**6 – Remote Control & Load Disconnect**

These remote control features require a customer-supplied normally-closed contact suitable for a 5 V dc low energy circuit. Refer to the wiring diagram provided with the ATS. Activate the appropriate DIP switch S3 actuators as shown in Tables E, F, or G. See Figure 7.

**Remote test**

Normally-closed input. When opened, it simulates a utility failure. The generator is signalled to start immediately and the load transfers to the generator (if acceptable). If the generator fails, the load stays on the generator until the remote test circuit is closed.

Table E. Remote test

Function	Factory Setting	DIP Switch	DIP Actuator	Actuator Position
disabled	disabled (on)	S3	3	on (up)
enabled				off (down)

**Remote test (with automatic retransfer)**

Normally-closed input. When opened, it simulates a utility failure. The generator is signalled to start immediately and the load transfers to the generator (if acceptable). If the generator fails, the load transfers back to the utility (if acceptable).

Table F. Remote transfer to generator

Function	Factory Setting	DIP Switch	DIP Actuator	Actuator Position
disabled	disabled (on)	S3	2	on (up)
enabled				off (down)

**Bypass load transfer to utility time delay**

Normally-closed input. When opened, it bypasses or cancels the generator to utility load transfer time delay. The load transfers back to the utility.

Table G. Bypass load transfer to utility delay

Function	Factory Setting	DIP Switch	DIP Actuator	Actuator Position
disabled	disabled (on)	S3	1	on (up)
enabled				off (down)

**Load disconnect feature**

Connect external circuits to the terminals indicated on the wiring diagram. The double throw (Form C) contact operates prior to a selectable 0, 3, 10, or 20 second delay before transfer of the ATS. The contact resets either immediately following transfer or after the same delay as set for presignal before transfer. Time delay between the load disconnect control signal and initiation of transfer is set on the controller DIP switch S3 (actuators 6, 7, 8).

\* Enabling the delay after transfer will cause the control signal to reset after the same delay as set for the delay before transfer.

**7 – Factory Settings – Summary**

Table H. Factory Settings – Summary

DIP Switch	DIP Actuator	Actuator Position
S1	1	on (up)
	2	off (down)
	3	on (up)
	4	off (down)
	5	off (down)
	6	on (up)
	7	off (down)
	8	off (down)
	9	off (down)
	10	on (up)
S2	1	off (down)
	2	on (up)
	3	off (down)
	4	on (up)
	5	on (up)
	6	on (up)
	7	on (up)
	8	on (up)
	9	off (down)
	10	off (down)
S3	1	on (up)
	2	on (up)
	3	on (up)
	4	on (up)
	5	on (up)
	6	off (down)
	7	on (up)
	8	on (up)
	9	on (up)
	10	on (up)

Table I. Load disconnect delay before transfer

Function	Factory Setting	DIP Switch	DIP Actuator	Actuator Position
0 seconds	disabled	S3	7	on (up)
			8	on (up)
3 seconds		S3	7	on (up)
			8	off (down)
10 seconds		S3	7	off (down)
			8	on (up)
20 seconds		S3	7	off (down)
			8	off (down)

Table J. Load disconnect delay after transfer\*

Function	Factory Setting	DIP Switch	DIP Actuator	Actuator Position
disabled	disabled	S3	6	off (down)
enabled		S3	6	on (up)

After installing the Series 185 automatic transfer switch (ATS) perform the following three-part functional test.

## 1 – Manual Operation

A handle is provided on the transfer switch for maintenance purposes only. Manual operation of the transfer switch should be checked before it is energized (operated electrically).

### **⚠ WARNING**

Do not manually operate the transfer switch until both power sources are disconnected: open both circuit breakers.

1. Turn OFF both the utility and generator circuit breakers feeding the ATS. Verify that **ALL POWER IS OFF!**
2. **100–230 A**  
Grasp the maintenance handle and turn it quickly with your thumb and fingers to manually operate the transfer switch.  
**260–400 A**  
Insert the maintenance handle into the hole in the shaft, left side of the operator. Move the handle as shown to manually operate the transfer switch.
3. The switch should operate smoothly without binding. If it does not, check for shipping damage or construction debris.
4. After checking the manual operation, use the handle again to return the transfer switch to the utility source position.  
**100–230 A** see Figure 8.  
The letter **P** (utility) on the round weight is facing you.  
**260–400 A** see Figure 9.  
The letter **N** (utility) on the round weight is facing you.  
Remove the maintenance handle and store it on the transfer switch in the place provided.

### **NOTICE**

**260–400 A** Remove the maintenance handle before proceeding!

## 2 – Voltage Checks

The ATS is rated for 220–240 V ac 60 or 50 Hz. Verify that both the utility and generator sources are 220–240 V ac 60 or 50 Hz.

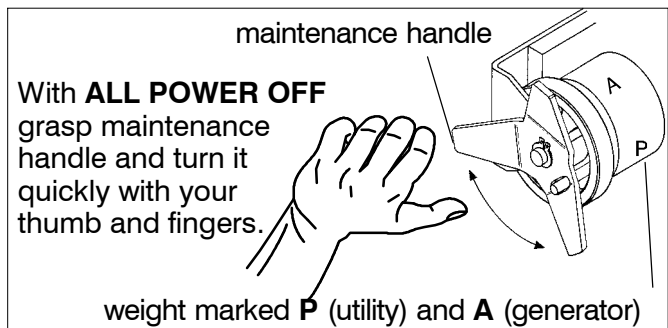

Figure 8. Maintenance handle for 100–230 A.

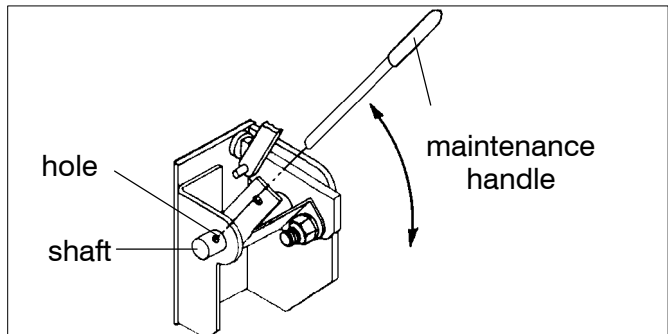

Figure 9. Maintenance handle for 260–400 A.

## 3 – Electrical Operation

This procedure checks the electrical operation of the ATS.

1. Install the enclosure cover and tighten the screws.
2. Verify that the generator battery is connected and that the generator's starting controls are set for automatic.
3. Turn on both the utility and generator circuit breakers.
4. Verify that the **Utility Acceptable** and **Load on Utility** lights are on.
5. This step will start the generator. Press and hold the **Transfer Test** button until the **Generator Acceptable** light comes on and stays on. Then release the button.
6. After the **Generator Acceptable** light comes on, the ATS transfers the load from the utility to the generator (after approx. 10 second delay). The **Load on Generator** light comes on.
7. The ATS stays connected to the generator for 5 minutes (approx.). The utility must be acceptable for 5 minutes continuously. Then the load is transferred back to the utility. To bypass time delay, press the **Bypass Time Delay** button.
8. After load retransfer to utility, the generator runs 2 minutes (without load), then shuts down. The **Generator Acceptable** light goes off indicating that the generator is off.

This completes the Functional Test.





This troubleshooting guide describes some of the simple causes of problems with the installation of the automatic transfer switch. Troubleshooting beyond the scope of this guide should not be attempted by the installer. A licensed electrician must perform all internal troubleshooting.

ASCO Power Technologies can be contacted at:  
1-800-800-2726 or [customercare@asco.com](mailto:customercare@asco.com)

## DANGER

**ELECTROCUTION FLASH HAZARD** Do not work on the transfer switch until both the utility and generator are off. Turn OFF both circuit breakers.

Problem	Cause and Solution
The <i>Utility Acceptable</i> light does not come on when utility power is connected to the ATS.	<ol style="list-style-type: none"> <li>1. Verify that the utility feed is connected and that its circuit breaker is ON.</li> <li>2. With <b>ALL POWER OFF</b>, verify that the utility feed is 220–240 V ac and 60 Hz. Check DIP switch S2 actuator 2, and DIP S1 actuator 4. See Table D for voltage and frequency settings.</li> <li>3. With <b>ALL POWER OFF</b>, verify that the utility feed is wired to the terminal lugs on the bottom of the transfer switch marked L1 and L5. See the wiring diagram.</li> <li>4. With <b>ALL POWER OFF</b>, verify that the transfer switch harness is connected properly to the controller (plug and receptacle tight).</li> </ol>
The generator does not crank when the utility source fails or when the <i>Transfer Test</i> button is pressed.	<ol style="list-style-type: none"> <li>1. Hold the <i>Transfer Test</i> button for at least 15 seconds.</li> <li>2. Verify that the generator starting controls are set for automatic operation (not in manual mode).</li> <li>3. Verify that the generator battery is connected and that the battery voltage meets the generator manufacturer's recommendation.</li> <li>4. Verify that the correct contact (normally open or normally closed) is being utilized (see the generator manual).</li> <li>5. With <b>ALL POWER OFF</b>, verify engine start low voltage wiring between the controller terminal block and the generator. See the wiring diagram. Check that the plug is properly seated in the receptacle on the controller.</li> </ol>
The generator cranks but does not start and run when the utility source fails or when the <i>Transfer Test</i> button is pressed.	<ol style="list-style-type: none"> <li>1. Verify proper generator operation (fuel in tank, oil level, spark plugs – see generator manual).</li> <li>2. With <b>ALL POWER OFF</b>, verify engine start low voltage wiring between the controller terminal block and the generator. See the wiring diagram. Check that the plug is properly seated in the receptacle.</li> </ol>
The generator starts and runs but the <i>Generator Acceptable</i> light does not come on.	<ol style="list-style-type: none"> <li>1. Verify that the generator feed is connected and that its circuit breaker is ON.</li> <li>2. With <b>ALL POWER OFF</b>, verify that the generator feed is 220–240 V ac and 60 Hz. Check DIP switch S2 actuator 2, and DIP S1 actuator 4. See Table D for voltage and frequency settings.</li> <li>3. With <b>ALL POWER OFF</b>, verify that the generator feed is wired to the terminal lugs on the top of the transfer switch marked L2 and L6. See the wiring diagram.</li> <li>4. With <b>ALL POWER OFF</b>, verify that the transfer switch harness is connected properly to the controller (plug and receptacle tight).</li> <li>5. Verify generator ac output (voltage and frequency – see generator manual).</li> </ol>
The generator starts and runs but the ATS does not transfer the load to the generator.	<ol style="list-style-type: none"> <li>1. Verify that the <i>Generator Acceptable</i> light is on. If it is off, see previous troubleshooting problem. The ATS will not transfer the load to an unacceptable source.</li> <li>2. With <b>ALL POWER OFF</b>, verify that the transfer switch harness is connected properly to the controller (plug and receptacle tight).</li> </ol>

Problem	Cause and Solution
The ATS does not immediately transfer the load to the generator.	<ol style="list-style-type: none"> <li>1. Verify that the <i>Generator Acceptable</i> light is on. If it is off, see previous troubleshooting problem. The ATS will not transfer the load to an unacceptable source.</li> <li>2. Wait approximately 10 seconds for the transfer to generator time delay. This fixed delay allows the generator output to stabilize before a load is applied to it.</li> <li>3. Press the <i>Bypass Time Delay</i> button for immediate load transfer to the generator.</li> </ol>
The ATS transfers the load to the generator, but the generator bogs down (struggles or slows down). The ATS retransfers back to the utility.	<ol style="list-style-type: none"> <li>1. The generator may be overloaded. Check to see if the generator circuit breaker tripped. Check the sum of the loads to be sure it does not exceed the capacity of the generator. Some motor loads require three times more power for starting.</li> <li>2. Check for short circuit in a connected load.</li> <li>3. Observe the <i>Load on Utility</i> and <i>Load on Generator</i> lights.</li> </ol>
The generator stops after a running for awhile. The ATS retransfers back to the utility (if acceptable).	<ol style="list-style-type: none"> <li>1. Verify proper generator operation; it may have run out of fuel or shut down because of low oil level (see generator manual).</li> <li>2. The generator may be overloaded. Check to see if the generator circuit breaker tripped. Check the sum of the loads to be sure it does not exceed the capacity of the generator. Some motor loads require three times more power for starting.</li> <li>3. Check for short circuit in a connected load.</li> <li>4. Observe the <i>Load on Utility</i> and <i>Load on Generator</i> lights.</li> </ol>
The ATS does not retransfer the load back to the utility.	<ol style="list-style-type: none"> <li>1. Verify that the <i>Utility Acceptable</i> light is on. The ATS will not transfer the load to an unacceptable source.</li> <li>2. Wait approximately 5 minutes for the retransfer to utility time delay. The utility must be acceptable for 5 minutes continuously.</li> <li>3. Press the <i>Bypass Time Delay</i> button for immediate load retransfer to the utility.</li> </ol>
The ATS retransfers the load back to the utility but the generator keeps running.	<ol style="list-style-type: none"> <li>1. Wait approximately 2 minutes for the unloaded running (engine cooldown) time delay.</li> <li>2. The engine cooldown fixed time delay is important to prevent generator damage.</li> </ol>
The generator exerciser does not seem to work.	<ol style="list-style-type: none"> <li>1. Verify that the <i>Automatic Generator Exerciser</i> status light is blinking. <ul style="list-style-type: none"> <li>– Light blinks during the exercise period. (when the generator is running and during cooldown).</li> <li>– Light stays on when then exerciser has been set.</li> <li>– When light is off, no exercise period is set.</li> </ul> </li> <li>2. With <b>ALL POWER OFF</b>, verify that the exerciser is turned on. Check DIP switch S1 actuator 7, and S2 actuator 10. See Table B for generator exerciser settings.</li> <li>3. With <b>ALL POWER OFF</b>, check the 9 volt battery. Replace, if necessary, with a quality alkaline battery: <i>Duracell MN1404</i>, <i>Everready 522</i>, <i>Panasonic 6AM6</i>, or equivalent. See Figure 5.</li> </ol>
The generator exerciser does not transfer the load to the generator.	<ol style="list-style-type: none"> <li>1. With <b>ALL POWER OFF</b>, verify that exercise with load is turned on. Check DIP switch S1 actuator 8. See Table B for generator exerciser settings.</li> </ol>

**A**

Automatic Generator Exerciser, 2, 3, 9

**B**

battery, clock, 3

buttons, push, 2

Bypass Time Delay, button, 2, 6

**C**

cable spacers, 1

catalog number, inside cover

clock battery, 3

connections

electrical power, 1

engine control contact, 1

contacts

engine control, 1

control features, remote, 5

controller, 2–5

**D**

DIP switches, 3–5

dropout, 4

**E**

electrical operation, 2, 6

electrical power connections, 1

engine exerciser, 2, 3, 9

**F**

features, *see* control features

frequency, pickup and dropout, 4

functional test, 6

**G**

generator

exerciser, 2, 3, 9

frequency, 4

settings, 4

starting contacts, 3

voltage, 4

Generator Acceptable, light, 2, 7, 9

ground connection, inside cover

**H**

handle, maintenance, 6  
warning, 6

harness, inside cover

HELP

800–800–2726 (ASCO)

customer@asco.com

**I**

indicator lights, 2

installation, 1

insulator, backing piece, 1

illustration of, 6

warning, 6

**L**

labels,

operator, transfer switch, 6

rating, cover

lights, 2, 7

load disconnect feature, 5

Load on Generator, light, 2, 7

Load on Utility, light, 2, 7

**M**

manual operation, 6

illustration of, 6

warning, 6

mounting, 1

**O**

operation

electrical, 6

manual, 6

sequence of, 7

override momentary outages, 4

**P**

pickup, 4

problem, 8–9

**R**

rating label, cover

remote control features, 5

bypass transfer time delay, 5

remote test, 5

remote transfer to emergency, 5

**S**

service,

800–800–2726 (ASCO)

customer@asco.com

Set Engine Exerciser, button, 2, 3

settings

changing, 3–5

factory, 3–5

frequency, 3, 4

phase, 4

time delay, 3, 4

voltage, 3, 4

source acceptable lights, 2

spacer, cable, 1

switches, DIP, 3–5

**T**

TB7 generator start connections, 3

terminal block, 1

test, functional, 6

time delay

adjustment, 3, 4

gen–set cooldown, 4

how to change, 3

override momentary outages, 4

settings, 3–5

transfer to emergency, 4

transfer to normal, 4

timer (gen exerciser), how to set, 3

transfer switch position lights, 2

Transfer Test, button, 2, 6

troubleshooting, 8–9

**U**

unloaded running, gen. cooldown, 4

Utility

failure, 7

frequency, 4

settings, 4

voltage, 4

Utility Acceptable, light, 2, 7, 9

**V**

voltage, phase, 4

voltage, pickup & dropout settings, 4

voltage checks, 6